

UT864 Terminal Technical Description

Rev. 0.2

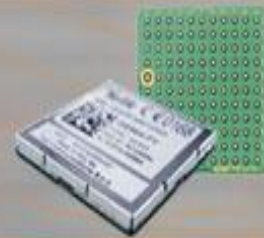
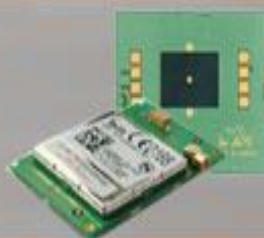

CEP AG

Raiffeisenallee 12b
82041 Oberhaching
Germany

Phone: +49 89 450 292 – 0
Fax: +49 89 450 292 – 22
Internet: www.cepag.de
Mail: info@cepag.de

Important information

This technical description contains important information for start up and use of the UT864 Terminal. Read it carefully before you start working with the UT864 Terminal. The warranty will be void should damage occur due to non-compliance with these instructions for use. We cannot accept any responsibility for consequential loss.

We cannot be held responsible for material loss or personal injury that is due to incompetent use or non-compliance with the safety instructions. The warranty will be void in such circumstances.

The UT864 Terminal contains highly integrated components which can be damaged by electrostatic discharge if the user would open the housing.

	Therefore only touch the UT864 Terminal on the housing or connectors and avoid touching the components on the board.
---	--

Safety Instructions

	When using products which are exposed to electric voltage the valid regulations have to be observed.
---	--

Before opening of a device always pull the mains adapter or make sure that the device is disconnected from the power supply.

You should only use tools on components, modules or devices if they are disconnected from the power supply and the electric charge, which may still be stored in some components, inside the device has been discharged.

All cables and wires which are energized and connected to the device, the module or components have to be checked regularly for any damage of the isolation shield or fractures of the cables. If the supply cables are visibly damaged the device has to be taken out of operation immediately until the faulty cable has been exchanged.

When using components or modules it is necessary to strictly observe the specification given in the corresponding description of these components. If a description for a private end-customer not clearly states which electric data is valid for a component or a module, how to wire the device, which external components or additional devices can be connected or which parameters these components are allowed to have, a specialist must be contacted.

Before putting a device into operation, it has to be clarified, whether this device or module is meant for the field of application. In case of doubt ask specialists or the manufacturer of the device. Please note that we are not responsible for any errors in usage or connection. Therefore we cannot accept any responsibility for consequential loss.

Devices which operate with >35 Volt have to be connected by a specialist. Before putting the device into operation it should be checked that there is no current leakage on the housing.

In case those measurements with the opened housing are necessary, an isolating-transformer has to be integrated for safety reasons. Alternatively the voltage can be supplied by an appropriate power supply which complies with the safety regulations. All wiring work has to be done in a voltage free state only.

Contents

Important information.....	2
Safety Instructions	2
1 Mechanical Description	4
1.1 Overview.....	4
1.2 Physical Dimensions and Weight	5
2 Electrical Description.....	6
2.1 Power Connector	6
2.2 Antenna Connector	7
2.3 SIM card reader	8
2.4 RS232 Serial Port	8
2.4.1 Serial Data	8
2.4.2 Serial Data Signals.....	9
2.4.3 Control Signals – RTS, CTS, DTR, DSR, DCD, RI	9
2.5 Mini USB Connector	10
3 Operation.....	11
3.1 Switching ON the modem	11
3.2 Switching OFF the modem	12
3.3 Operating states / LEDs	12
3.3.1 Power up LED (green LED in the middle).....	12
3.3.2 Status LEDs (one yellow, one red).....	12
4 Power consumption	12
5 Safety and Product Care.....	13
5.1 Safety instructions	13
5.2 General precautions	13
5.3 SIM card precautions.....	14
5.4 Antenna precautions	14
6 Installation of the modem.....	15
6.1 Where to install the modem.....	15
6.1.1 Environmental conditions.....	15
6.1.2 UMTS Signal strength.....	15
6.1.3 Connections of components to UT864Terminal.....	15
6.1.4 Network and Subscription	16
6.2 How to install the modem.....	16
6.2.1 Power supply	16
6.2.2 Securing the modem	16
6.3 Antenna.....	16
6.3.1 General	16
6.3.2 Antenna type.....	17
6.3.3 Antenna placement	17
6.3.4 The antenna cable	17
6.3.5 Possible communications disturbances	18
6.4 CEP Certified Accessories.....	18
7 Technical Data.....	19
8 Abbreviations	21
9 Mark of Conformity.....	22
9.1 CE Approval	22
9.2 RoHS Certificate.....	22
9.3 Safety Test	22
10 Service and Support.....	22
11 Documentation Change Log.....	22

1 Mechanical Description

1.1 Overview

The pictures below show the mechanical design of the UT864 Terminal along with the positions of the different connectors and mounting holes. The UT864 Terminal case is made of durable PC/ABS plastic.

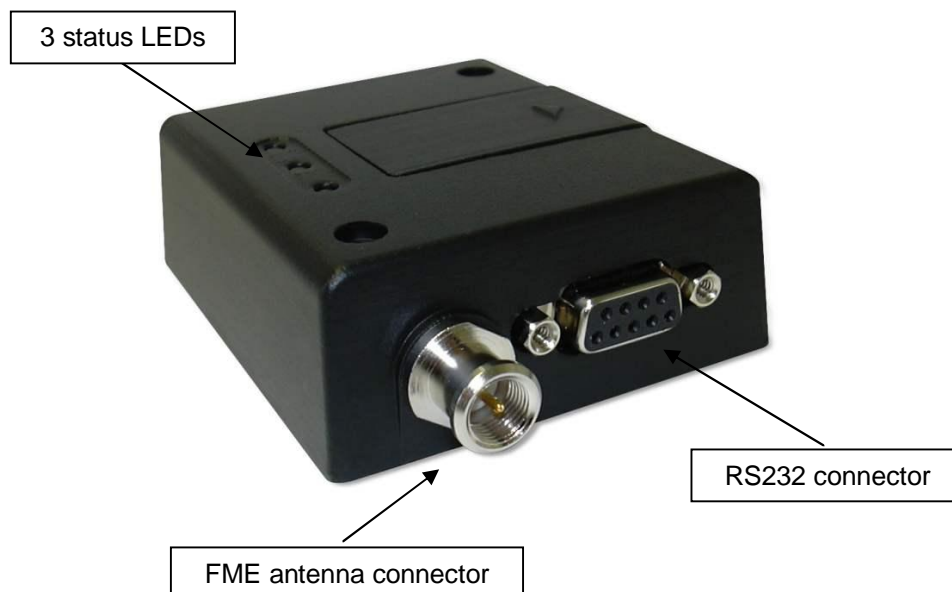
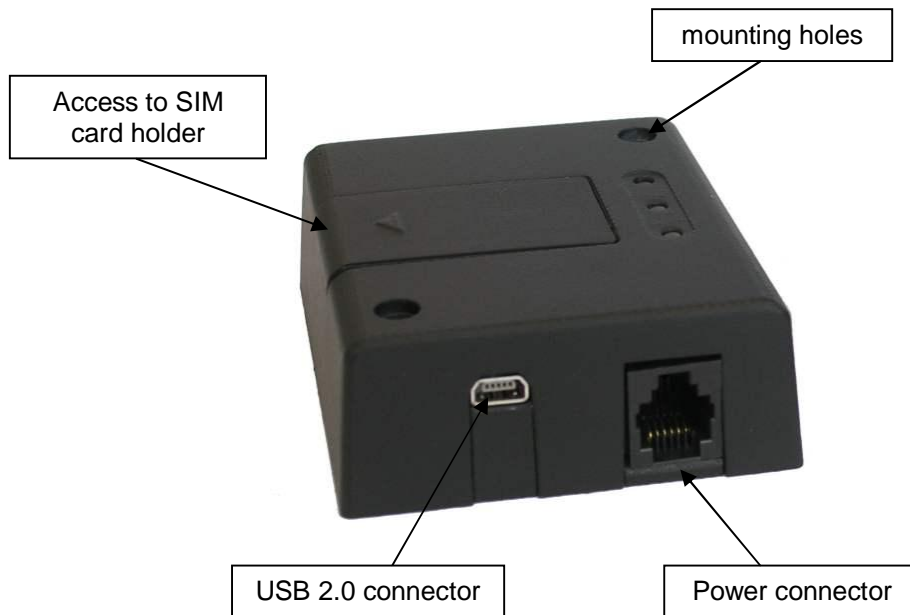

Please note the following:

- Mounting holes positioned at two of the corners make it possible to securely bolt the modem into your application.
- The SIM card is mounted in the modem, accessible by the user under a lid without any tools.
- The pins and electrical characteristics or the modem's various connectors are described in "2. Electrical Description"
- Information about the antenna connector is found in "2.2 Antenna Connector"

1.2 Physical Dimensions and Weight

Overall dimensions: 77 x 67 x 26 mm

Weight: approx. 90g

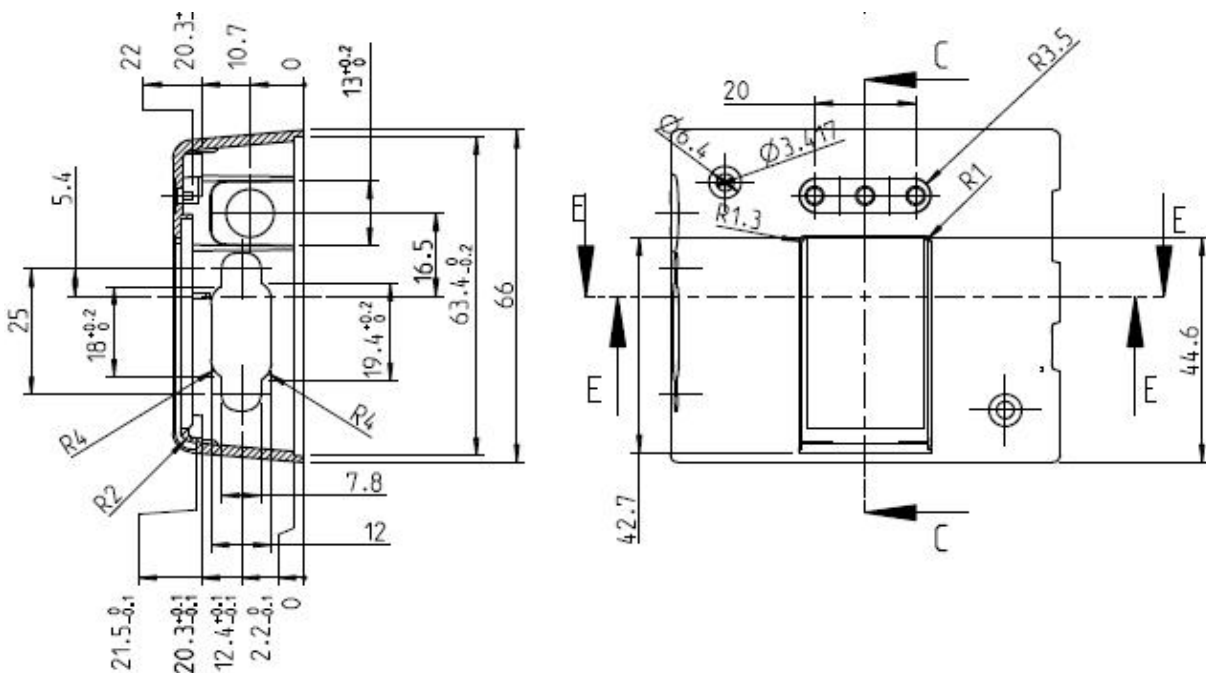
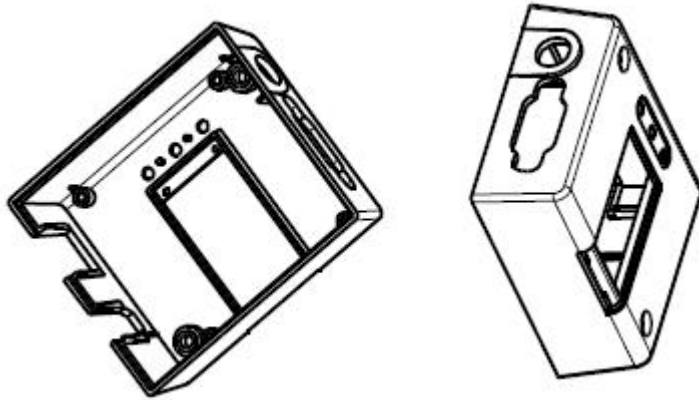

2 Electrical Description

The modem uses the following standard connectors:

- RJ11 6-way (power connector)
- Mini USB (USB 2.0)
- SIM card reader
- FME male coaxial jack (antenna connector)
- Sub-D female socket, 9 pin (RS232 serial port)

2.1 Power Connector

An RJ11 6-way connector, as shown and described below, serves as a means of supplying and controlling DC power to the modem. It is necessary to connect an external power supply, since the available power on the USB port is not sufficient to run the modem.

The supply voltage, VCC, required by the modem is 5V - 32V DC. Application of the supply voltage does not switch the modem on. To do so an additional active-high control signal, TO_IN, must be applied for > 1 second.

Please see chapter “3.1 Switching ON the modem” for further important details about TO_IN and power supply requirements, especially if TO_IN is applied in parallel to VCC.

VCC and GND are reverse-polarity and over-voltage protected.

Note: This does not apply for the GND on the antenna connector if this coax GND / shield are connected to your applications ground-plane.

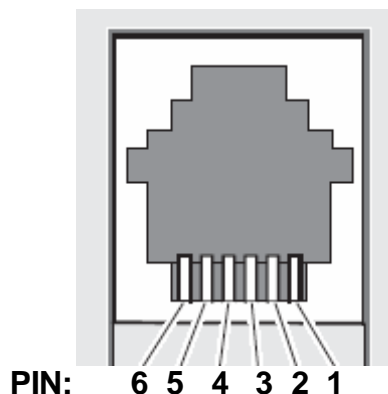

Pin	Description
1	VCC
2	-
3	HR_IN
4	TO_IN
5	-
6	GND

Signals of Power Connector

PIN	Signal	Direction	Limits	Description
1	VCC	Input	5 – 32V	Positive power input, DC
2	Not connected	Not connected	Not connected	Not connected
3	HR_IN	Input	5 – 32V	Active high control line used to switch off $V_{IH} > 5V$, $V_{IL} < 0.5V$ Power off: $1s < t < 2s$
4	TO_IN	Input	5 – 32V	Positive edge triggered signal; used to switch on the modem $V_{IH} > 5V$, $V_{IL} < 0.5V$ Power on: $t > 1s$
5	Not connected	Not connected	Not connected	Not connected
6	GND	Input	-	Negative power (ground) input and return path for TO_IN and HR_IN

2.2 Antenna Connector

The antenna connector allows transmission of radio frequency (RF) signals between the modem and an external customer-supplied antenna. The modem is fitted with a 50Ω, FME male coaxial jack.

Output Power:

0.25 Watt Peak (Class 3)	UMTS/HSDPA 2100 MHz
2 Watt Peak (Class 4)	GSM 900/850 MHz
1 Watt Peak (Class 1)	GSM 1800/1900 MHz

Description of recommended antenna parameters:

The antenna that the customer chooses to use should fulfil the following requirements:

Frequency range	UMTS/HSDPA 2100 MHz GSM 850/900 MHz GSM 1800/1900 MHz Depending by frequency band(s) provided by the network operator, the customer shall use the most suitable antenna for that/those band(s)
Bandwidth	80 MHz in EGSM 900, 70 MHz if GSM 850, 170 MHz in DCS, 140 MHz PCS band, 250MHz in WCDMA2100 band
Gain	< 3dBi
Impedance	50 ohm
Input power	> 33dBm (2W) peak power in GSM > 24dBm Average power in WCDMA2100

VSWR absolute max.	10:1
VSWR recommended	$\leq 2:1$

2.3 SIM card reader

The UT864 Terminal is fitted with a SIM card reader designed for 1.8V and for 3V SIM cards. It is the flip-up type which is lockable in the horizontal position and is accessed through a removable panel.

2.4 RS232 Serial Port

The modem supports a standard RS232 serial interface via its 9 pin Sub-D connector, shown below. In line with serial communication terminology the UT864 Terminal should be considered as the *data circuit-terminating equipment* (DCE) and the external application or computer as the *data terminating equipment* (DTE). The maximum baud rate to communicate with the UT864 Terminal is 230.4 kbit/s.

The electrical characteristics of the serial port signals are shown below:

PIN	Signal	Direction	Voltage levels	Description
1	DCD	Output	> +4V < -4 V	Data carrier detect
2	RD	Output	> +4V < -4 V	Received data
3	TD	Input	> +2,4V < 0.8 V	Transmitted data
4	DTR	Input	> +4V < 0.8 V	Data terminal ready
5	GND	-	0 V	Ground connection
6	DSR	Output	> +4V < -4 V	Data set ready
7	RTS	Input	> +2,4V < 0.8 V	Request to send
8	CTS	Output	> +4V < -4 V	Clear to send
9	RI	Output	> +4V < -4 V	Ring indicator

2.4.1 Serial Data

The modem supports the standard data character format of

- Programmable baud rate
- Auto-configuration mode with auto-baud.

2.4.2 Serial Data Signals

Serial Data From Modem (RD)

RD is an output signal that the modem uses to send data to the application.

Serial Data To Modem (TD)

TD is an input signal, used by the application to send data to the modem.

2.4.3 Control Signals – RTS, CTS, DTR, DSR, DCD, RI

Request to Send (RTS)

RTS is used to condition the DCE for data transmission. The default level is high by internal pull up. The exact behaviour of RTS is defined by an AT command. Software or Hardware control can be selected. Hardware flow is the default control. The application must pull RTS low to communicate with the modem. The modem will respond by asserting CTS low, indicating it is ready for communication.

Clear To Send (CTS)

CTS indicate that the DCE is ready to transmit data. The default level is high. You can define the exact behaviour of CTS through an AT command, and can select software or hardware flow control.

Data Terminal Ready (DTR)

DTR indicates that the DTE is ready to transmit and receive data. It also acts as hardware 'hang-up', terminating calls when switched high. The signal is active low. You can define the exact behaviour of DTR with an AT command. The DTR line can also be used to switch on the modem when activated for 0.2 seconds. The DTR line must be deactivated prior to switching off the modem to ensure it switches off (powers down) correctly.

Data Set Ready (DSR)

An active DSR signal is sent from the modem to the application (DTE) to confirm that a communications path has been established. DSR has two modes of operation, settable using the AT command AT&S.

Data Carrier Detect (DCD)

DCD indicates that the DCE is receiving a valid carrier (data signal) when low. You can define the exact behaviour of DCD with an AT command.

Ring Indicator (RI)

RI indicates that a ringing signal is being received by the DCE when low. You can define the exact behaviour for RI with an AT command.

2.5 Mini USB Connector

The modem supports a standard USB 2.0 interface for AT-commands. The maximum baud rate to communicate with the UT864 Terminal is up to 12 Mbit/s.

Drivers for several operating systems (e.g. Windows Vista, Windows XP or Linux) are available to be downloaded from www.cepag.de (please ask for password).

UT864 Pin Layout for Mini USB connector:

Pin	Signal
1	VUSB
2	D -
3	D +
4	ID
5	GND

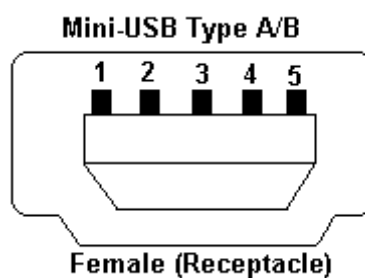

3 Operation

3.1 Switching ON the modem

There are two ways to switch on the modem, once power is applied.

- assert TO_IN to high level for > 1s
- activate the RS232 control line DTR

The modem is fully operational after 4 seconds. Logging onto a network may take longer than this and is outside the control of the modem. The modem can be configured to start up at the time power is applied by permanently tying power connector signals TO_IN (pin 4) and VCC (pin 1) together. In this case DTR must be used to switch the modem on again after it has been switched off or reset, while power is still applied.

Note: DTR must be cycled from low to high.

The TO_IN signal requires a positive “edge” (a sharp” signal transition from low to high) to turn the modem on. This transition should be a rising signal from 0V (GND) to VCC, or at least a large fraction of that voltage range, and

Note: must be applied at the same time as VCC or after it. Very slow transitions (significantly slower than many milliseconds) or very small transitions (e.g. only few volts instead of 0V to VCC) will not turn on the module (since they are not considered to be a “positive edge”).

Although this will not be an issue in almost all typical applications of the modem, please consider following points:

- Large capacitors in your power supply which will lead to slow leading and falling edges (issue does not apply with modern stabilized switching regulator power-adaptors) AND TO_IN tied in parallel to VCC (instead of separate dedicated digital signal)
- Slow analogue signals used to assert TO_IN
- TO_IN signal not before VCC

All 3 cases above might prevent the modem from recognizing the power-up signal this is no failure of the modem itself, the same would apply to almost any electronic device that provides a separate “power-on” or “reset” signal.

If you have any doubts, please

- Use the mains power adapter that is provided by your distributor and is known to work properly with your modem
- Make sure that your signal and system design is according to the above
- Consult our support team that will be more than happy to assist you.

3.2 Switching OFF the modem

There are two ways to switch off (power down) the modem as described below:

- use the AT#SHDN command; DTR permanently to low (0,8V) (under evaluation)
- HR_IN to high level for $1s < t < 2s$ (under evaluation)

A delay of up to 10s is experienced as the modem logs off the network

3.3 Operating states / LEDs

3.3.1 Power up LED (green LED in the middle)

The modem has a green power up LED, as depicted below, which is used to indicate various operating states. These states are described in following table.

Operating state of UT864Terminal	Power up LED state
Device off	Permanently off
net search / not registered /	Fast blinking (period=1s, LED _{on} =0,5s)
registered full service	Slow blinking (period=3s, LED _{on} =0,3s)
A call is active	Permanently on

3.3.2 Status LEDs (one yellow, one red)

These LEDs can be controlled e.g. by an external microcontroller via at-commands issued to the terminal via the serial RS232 interface or via the USB-port. They can be used for signalling any useful status of the external application such as:

- error indication
- status of communication (UMTS, GPRS, SMS, CSD, etc.)
- status of GSM-network (to simulate GSM LED)
- quality of service

4 Power consumption

The following table shows you the power consumption of the UT864 Terminals in different modes:

UT864 Terminal

	[mA] @ 5V	[mA] @ 12V	[mA] @ 24V	[mA] @ 32V
UT864 off				
UT864 idle mode (lab conditions, 21°)	42	17	10	8
UT864 with data call				

Off means: UT864 powered via VCC; switched off via HR_IN

Idle mode means: UT864 registered to the mobile network; no transmission

With data call means: typical value during data/fax transmission via GSM900 (power level5; 2 Watts).

5 Safety and Product Care

Please read the information in this section and the information in “Installation of the Modem”, before starting your integration work!

5.1 Safety instructions

PLEASE READ THESE SAFETY INSTRUCTIONS AND KEEP A COPY OF THEM.

- Always ensure that use of the modem is permitted. The modem may present a hazard if used in proximity to personal medical electronic devices. As a rule, the modem must not be used in hospitals, airports or planes.
- Never use the modem at a gas station, refuelling point, blasting area or in any other environment where explosives may be present.
- Operating the modem close to other electronic devices, such as antennas, television sets, and radios may cause electromagnetic interference.
- This product is intended to be used with the antenna or other radiating element at least 20cm away from any part of the human body. In applications where this rule cannot be applied, the application designer is responsible for providing the SAR measurement test report and declaration.
- You are responsible for observing your country's safety standards, and where applicable, the relevant wiring rules.

5.2 General precautions

The UT864Terminal as a stand alone item is designed for indoor use only. To use outside it must be integrated into a weatherproof enclosure. Do not exceed the environmental and electrical limits as specified in “Technical Data”.

- Avoid exposing the modem to lighted cigarettes, naked flames or to extreme hot or cold temperature.
- Never try to dismantle the modem yourself. There are no components inside the modem that can be serviced by the user. If you attempt to dismantle the modem, you may invalidate the warranty.
- The UT864Terminal must not be installed or located where the surface temperature of the plastic case may exceed 85°C.
- All cables connected to the UT864Terminal must be secured or clamped, immediately adjacent to the modem's connectors, to provide strain relief and to avoid transmitting excessive vibration to the modem in the installation.
- Ensure the cables, supplying power does not exceed 3 metres.
- To protect power supply cables and meet the fire safety requirements when the unit is powered from a battery or a high current supply, connect a fast 1.25A fuse in line with the positive supply.
- Do not connect any incompatible component or product to the UT864Terminal.

Note: AG may refuse warranty claims where evidence of product misuse is found.

5.3 SIM card precautions

Before handling the SIM card in your application, ensure that you are not charged with static electricity. Use proper precautions to avoid electrostatic discharges.

- When the SIM card hatch is opened, the SIM card connectors lie exposed under the SIM card holder.

Caution! Do not touch these connectors! If you do, you may release an electrical discharge that could damage the modem or the SIM card.

- When designing your application, the SIM card's accessibility should be taken into account. We always recommend that you have the SIM card protected by a PIN code. This will ensure that the SIM card cannot be used by an unauthorized person.

5.4 Antenna precautions

If the antenna is to be mounted outside, consider the risk of lightning. Follow the instructions provided by the antenna manufacturer.

- Never connect more than one modem to a single antenna. The modem can be damaged by radio frequency energy from the transmitter of another modem.
- Like any mobile station, the antenna of the modem emits radio frequency energy. To avoid EMI (electromagnetic interference), you must determine whether the application itself, or equipment in the application's proximity, needs further protection against radio emission and the disturbances it might cause. Protection is secured either by shielding the surrounding electronics or by moving the antenna away from the electronics and the external signals cable.
- The modem and antenna may be damaged if either come into contact with ground potentials other than the one in your application. Beware, ground potential are not always what they appear to be.

6 Installation of the modem

This chapter gives you advice and helpful hints on how to integrate the UT864Terminal into your application from a hardware perspective. Please read the information given in “Safety and Product Care”, page 10 and then read the information in this section before starting your integration work.

6.1 Where to install the modem

There are several conditions which need to be taken into consideration when designing your application as they might affect the modem and its function. They are:

6.1.1 Environmental conditions

The modem must be installed so that the environmental conditions stated in the Technical Data chapter, such as temperature, humidity and vibration are satisfied. Additionally, the electrical specifications in the Technical Data section must not be exceeded.

6.1.2 UMTS Signal strength

The modem has to be placed in a way that ensures sufficient UMTS signal strength. To improve signal strength, the antenna can be moved to another position. Signal strength may depend on how close the modem is to a radio base station. You must ensure that the location, at which you intend to use the modem, is within the network coverage area. Degradation in signal strength can be the result of a disturbance from another source, for example an electronic device in the immediate vicinity. More information about possible communication disturbances can be found in section 5.3.5.

When an application is completed, you can verify signal strength by issuing the AT command AT+CSQ. See “AT+CSQ Signal Strength”.

Tip! Before installing the modem, use an ordinary mobile telephone to check a possible location for it. In determining the location for the modem and antenna, you should consider signal strength as well as cable length

6.1.3 Connections of components to UT864Terminal

The integrator is responsible for the final integrated system. Incorrectly designed or installed, external components may cause radiation limits to be exceeded. For instance, improperly made connections or improperly installed antennas can disturb the network and lead to malfunctions in the modem or equipment.

6.1.4 Network and Subscription

Before your application is used, you must ensure that your chosen network provides the necessary telecommunication services. Contact your service provider to obtain the necessary information.

- If you intend to use SMS in the application, ensure this is included in your (voice) subscription.
- Consider the choice of the supplementary services

6.2 How to install the modem

6.2.1 Power supply

- Use a high-quality power supply cable with low resistance. This ensures that the voltages at the connector pins are within the allowed range, even during the maximum peak current.
- When the unit is powered from a battery or a high current supply, connect a fast 1.25A fuse in line with the positive supply. This protects the power cabling and modem.

6.2.2 Securing the modem

Before securing the modem take into account the amount of additional space required for the mating connectors and cables that will be used in the application.

- Where access is restricted, it may be easier to connect all the cables to the modem prior to securing it in the application.
- Securely attach the UT864 Terminal modem to the host application using two 3mm diameter pan-head screws

6.3 Antenna

6.3.1 General

The antenna is the component in your system that maintains the radio link between the network and the modem. Since the antenna transmits and receives electromagnetic energy, its efficient function will depend on:

- the type of antenna (for example, circular or directional);
- the placement of the antenna;
- communication disturbances in the vicinity in which the antenna operates.

In the sections below, issues concerning antenna type, antenna placement, antenna cable, and possible communication disturbances are addressed. In any event, you should contact your local antenna manufacturer for additional information concerning

antenna type, cables, connectors, antenna placement, and the surrounding area. You should also determine whether the antenna needs to be grounded or not. Your local antenna manufacturer might be able to design a special antenna suitable for the application.

6.3.2 Antenna type

Make sure that you choose the right type of antenna for the modem. Consider the following requirements:

- the antenna must be designed for the one of the frequency bands in use; please ask your network provider for more information:
 - GSM 850/900 MHz
 - GSM 1800/1900 MHz;
 - UMTS/HSDPA 2100 MHz
- the impedance of the antenna and antenna cable must be 50Ω;
- the antenna output-power handling must be a minimum of 2W;
- the VSWR value should be less than 3:1 to avoid any damage to the modem.

6.3.3 Antenna placement

The antenna should be placed away from electronic devices or other antennas. The recommended minimum distance between adjacent antennas, operating in a similar radio frequency band, is at least 50cm. If signal strength is weak, it is useful to face a directional antenna at the closest radio base station. This can increase the strength of the signal received by the modem. The modem's peak output power can reach 2W. RF field strength varies with antenna type and distance. At 10cm from the antenna the field strength may be up to 70V/m and at 1m it will have reduced to 7V/m. In general, CE-marked products for residential and commercial areas, and light industry can withstand a minimum of 3V/m.

6.3.4 The antenna cable

Use 50Ω impedance low-loss cable and high-quality 50Ω impedance connectors (frequency range up to 2GHz) to avoid RF losses. Ensure that the antenna cable is as short as possible. The Voltage Standing-Wave Ratio (VSWR) may depend on the effectiveness of the antenna, cable and connectors. In addition, if you use an adapter between the antenna cable and the antenna connector, it is crucial that the antenna cable is a high-quality, low-loss cable. Minimize the use of extension cables, connectors and adapters. Each additional cable, connector or adapter causes a loss of signal power.

6.3.5 Possible communications disturbances

Possible communication disturbances include the following:

- **Noise** can be caused by electronic devices and radio transmitters.
- **Path-loss** occurs as the strength of the received signal steadily decreases in proportion to the distance from the transmitter.
- **Shadowing** is a form of environmental attenuation of radio signals caused by hills, buildings, trees or even vehicles. This can be a particular problem inside buildings, especially if the walls are thick and reinforced.
- **Multi-path fading** is a sudden decrease or increase in the signal strength. This is the result of interference caused when direct and reflected signals reach the antenna simultaneously. Surfaces such as buildings, streets, vehicles, etc., can reflect signals.
- **Hand-over** occurs as you move from one cell to another in the GSM network. Your mobile application call is transferred from one cell to the next. Hand-over can briefly interfere with communication and may cause a delay, or at worst, a disruption.

6.4 CEP Certified Accessories

Product	Part No	Description
Power supply 230V AC / 12 VPC	12002	6pin RJ11 connector
Power cable	12003	6pin RJ11 connector with open ends
UMTS magnetic antenna	12014	5band magnetic antenna with 2.m cable and FME connector
UMTS stub antenna	12015	5band rectangular antenna with FME connector
RS232 cable	12004	1.5m for PC connection
USB cable	12302	Mini USB connector / USB A connector

Please contact your distributor or CEP AG for availability or check CEP's webpage www.cepag.de.

7 Technical Data

Product features:

- Single-band UMTS/HSDPA 2100 Power class 3 (0.25 W)
- Quad-band EGSM 850/900/1800/1900 MHz
- GSM 850/900 Power class 4 (2W)
- GSM 1800/1900 Power class 1 (1W)
- Control via AT commands according to GSM 07.05, 07.07 and proprietary Telit
- USB 2.0 full speed interface
- Supply voltage range: 5 – 32 V/DC
- TCP stack with IP and UDP protocols
- Sensitivity:
 - 107 dBm (typ.)@ 850/900 MHz
 - 106 dBm (typ.)@ 1800/1900 MHz
 - 108.2 dBm (typ.) @ 850/1900/2100 MHz
- Overall dimensions (excluding connectors): 77 x 67 x 26mm
- Weight: approx. 90g
- RoHS compliant
- Temperature range
 - -30°C to +75°C (Operational)
 - -40°C to +85°C (Storage temperature)

Interfaces:

- Sub-D female 9 pin connector for RS232 communication
- RJ11 Power: 5 – 32 Volt / DC
- Antenna: 50 Ohm (FME male)
- SIM card reader: 1.8V and 3V interface
- Mini USB Interface

Approvals:

- CE approval

SMS:

- Point to Point mobile originated and mobile terminated SMS
- SMS cell broadcast compatible with CB DRX
- Text and PDU mode

Circuit switched data transmission:

- Asynchronous transparent circuit switched Data (CSD) up to 14,4 kbps
- Asynchronous non-transparent circuit switched Data (CSD) up to 14,4 kbps

Data Transmission:

- WCDMA/HSDPA category 8, MS Class A
- Simultaneous Voice and Data
- EGPRS/GPRS Class 12
- Mobile station class B

Fax:

- Fax Group 3, class 1

GSM supplementary:

- Call forwarding
- Call barring
- Call waiting and hold
- Calling Line Identification Presentation (CLIP)
- Calling Line Identification Restriction (CLIR)

Internet Protocol:

- Embedded TCP/IP stack, including TCP/IP, UDP, SMTP and FTP protocol

Additional Features:

- Voice and SMS
- TCP stack with IP and UDP protocols
- Standard and extended AT command set
- Minimal power consumption

Telits EASY features:

- EASY GPRS (AT driven embedded TCP/IP protocol stack)
- EASY SCAN (full GSM frequency scanning)

Other features:

- 3x LED for status indication

8 Abbreviations

Abbreviation	Explanations
CBM	Cell Broadcast Message
CBS	Cell Broadcast Service
CSD	Circuit Switched Data
DCE	Data Circuit Terminating Equipment
DTE	Data Terminal Equipment
DTMF	Dual Tone Multi Frequency
EFR	Enhanced Full Rate
EMC	Electro-Magnetic Compatibility
ETSI	European Telecommunication Standards Institute
FR	Full Rate
GPRS	General Packet Radio Service
GSM	Global System for Mobile Communication
HR	Half Rate
HSDPA	High Speed Data
ITU-T	International Telecommunication Union - Telecommunications Standardisation Sector
ME	Mobile Equipment
MO	Mobile Originated
MS	Mobile Station
MT	Mobile Terminated
PDU	Protocol Data Unit
RLP	Radio Link Protocol
RF	Radio Frequency
RTC	Real Time Clock
SIM	Subscriber Identity Module
SMS	Short Message Service
TA	Terminal Adapter
TE	Terminal Equipment
UMTS	Universal Mobile Telecommunication System

9 Mark of Conformity

The UT864Terminal will carry the following certificates:

9.1 CE Approval

9.2 RoHS Certificate

9.3 Safety Test

Tested on the basis of IEC60950-1 First Edition

10 Service and Support

To contact customer support please use the contact details below:

Customer Support
CEP AG
Raiffeisenallee 12b
82041 Oberhaching
Germany
E-mail: support@cepag.de
or
Tel. +49-89-450 292 – 11

Information about CEP AG, products and accessories is available on the following web site: <http://www.cepag.de>

Note: CEP AG may, at any time and without notice, make changes or improvements to the products and services offered and / or cease producing or commercializing them.

11 Documentation Change Log

Revision	Date	Changes
Rev 0.1	15.01.2009	Initial Release
Rev 0.2	16.01.2009	Formatting, little changes